

SCORPION

Thermal Inkjet Coder



Ice

SCORPION

Thermal Inkjet Coder

Revolutionising thermal inkjet technology, the Scorpion prints high resolution codes on hard to print surfaces using a purpose-built inkjet cartridge with high performance MEK ink.

The Scorpion introduces an innovative Cartridge Readiness System™ - a high speed shutter system which prevents ink from drying in the nozzle during production interruptions. This provides clean, repeatable high quality codes even after a long stoppage.

At linear speeds up to 102 metres/minute, the Scorpion can print either simple text or more complex marks for a range of non-porous substrates in the packaged food, pharmaceutical and cosmetics industries.

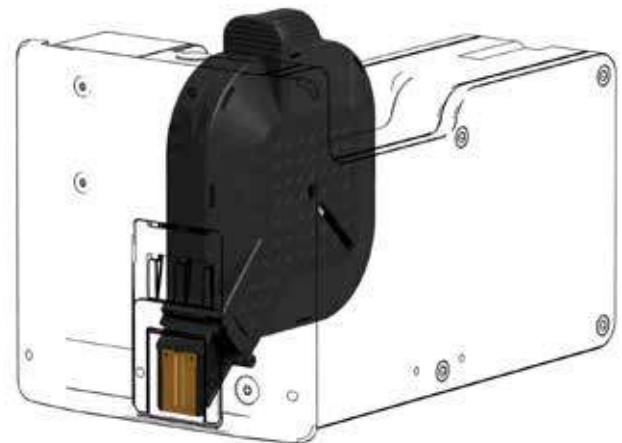

Flexibility to print on a wide range of packaging

- › Print high resolution text, barcodes and graphics on films, foils, plastics and coated stocks.
- › Designed to print on the top of a package or print horizontally on the side of a box.
- › The cartridge provides a 13.5mm tall print array for printing at resolutions up to four times greater than continuous inkjet technology.
- › Drive up to two independent printheads with each controller to print more content when required.
- › Purpose-built fast drying MEK compatible thermal inkjet cartridge.

Keep production moving and maintain print quality

- › High speed shutter system engages automatically to cap printhead when not in use and ensures line stoppages do not damage the print quality, ensuring continuous print.
- › Simple cartridge change in less than 15 seconds.
- › Linear print speeds of up to 102 metres per minute.
- › Rugged, industrial design made to withstand challenging production environments.

Industrial printing with exceptional simplicity

- › Minimal maintenance with only an occasional wipe of the print array and the shutter required.
- › No calibration procedures or tuning required.
- › No pumps or pressurised systems.
- › No compressed air.
- › No wear parts that require periodic replacement.
- › Easy to learn, quick and error-proof CLARiTY touchscreen interface provides step-by-step guidance and job set up.

Ready to print when you are with no manual intervention required



The shutter system closes after a user-defined time period. A seal is then created, helping to prevent ink from drying in the nozzle array.



When production resumes, the shutter system automatically opens and the Scorpion is ready to apply a high quality code - no printhead intervention required.



30 seconds between prints - gap in production flow

2 minutes between prints - typical random interruption

20 minutes between prints - printer interrupted for operator break

Light solvent ink in conventional TIJ cartridge

 EXP 30-09-2015
ICE A12345T

 EXP 30-09-2015
ICE A12345T

 EXP 30-09-2015
ICE A12345T

Scorpion running MEK ink with shutter system

 EXP 30-09-2015
ICE A12345T

 EXP 30-09-2015
ICE A12345T

 EXP 30-09-2015
ICE A12345T

Substrate versatility
Code on a wide range of substrates in high resolution.



Multi-line code with customer facing information

Coding versatility

Print a variety of fonts, barcodes and graphics

Font type and sizes



ICE Scorpion



Bar codes



Graphics

8 pt Arial
10 pt Arial
12 pt Arial

12 pt Verdana
18 pt Tahoma

OCR A - ICE Scorpion
OCR B - ICE Scorpion



Large (1/2" high) line code with information on product source



Multi-line mixed height code with customer loyalty information



GS1 DataMatrix code with human readable for pharmaceutical traceability

A closer look at CLARITY™

Coder Operating System

CLARITY™ ensures secure, streamlined management of data, minimising downtime and protecting brand integrity.

REDUCE...

- › **Rework** by eliminating coding errors.
- › **Recalls** by consistent coding with traceability.
- › **Risk** by delivering accurate legible codes.



- › Unique date calculation manager to configure offset dates, avoidance date rules and controlled concessions.
- › Windows TrueType fonts for flexible label design.
- › Intuitive high-resolution graphical user interface with icon based controls, WYSIWYG image display and colour touchscreen.
- › Multiple language functionality.
- › Limited operator intervention required minimises risk of errors with sell-by dates, traceability codes, product variety and country of origin.
- › Transfer of data and images via a USB port.



- › USB scanpoint feature allows job selection via barcode scanning with no operator intervention and no human error.



- › Allows precise synchronisation and integration with weighing systems.
- › Web browser to allow seamless OEM integration and remote diagnostics.
- › Real time view of the performance of all ICE printers in the factory.



- › The patented generic file structure of CLARITY™ ensures future compatibility with your choice of coder technology.
- › Network capability for plant-wide solutions when used with CLARINET® package coding network control software.

Performance

Printer

Printhead	1 printhead 13.5mm	2 printhead 27.0mm
Print height	Up to 2 independent 13.5mm high print areas Fields can be independently placed within the print area Maximum lines of code is font size dependent (4 lines at 6 pts)	
Printhead dimensions <i>Dimensions exclude cartridge and cable connections</i>	194.60mm long 120.80mm high 122.60mm wide (at rub plate)	
Printhead mounting	Side or top orientation Directly to conveyance system or optional printhead stand	
Print speed/resolution capability <i>Print speeds and throughput are resolution, substrate, application and set-up dependent</i>	240 x 240 dpi = 51 m/min 240 x 180 dpi = 68 m/min 240 x 120 dpi = 102 m/min	
Controller dimensions <i>Dimensions exclude cartridge and cable connections</i>	245.70mm wide 142.90mm deep 203.20mm high	
Ink cartridge	42 millilitres nominal Drop size = 48 picolitres 2mm recommended throw distance	

General

8.4" TFT SVGA (800 x 800) touch screen operator interface	On-board diagnostics
Full-colour LCD touch panel interface WYSIWYG print preview	On-board memory, compact flash and/or expansion card
3 levels of password protection	Job selection and database support as standard

Software

CLARISOFT® Image Design Software	Auto best before date calculation and concession management
Full downloadable font support for Windows TrueType fonts (including multiple languages and Unicode support)	Scalable text including rotation, mirror and inverse printing
Fixed, variable and merged text fields	Flexible date/time formats
Link fields to databases	Real-time clock functions
Formats for shift coding	Auto increment/decrementing text, counters and barcodes
Mirror image printing, image rotation	User configurable drop-down list fields
Basic shape drawing	128Mb message store memory
Barcodes EAN8, EAN13, UPC-A, UPC-E, CODE 39, CODE128, EAN128, GS1 DataBar (including 2D composite), DataMatrix, QR, PDF417	

Connectivity

External inputs (fully software configurable)	USB memory stick support
External outputs	ZPL II emulation
RS232	Text communication
Ethernet	CLARINET® coder independent network management software

Services

Power supply	100 - 240V AC, 50 - 60Hz
Operating temperature	5° - 40°C
Approximate weight (controller)	10.7 lbs (4.9 kgs)

Regulatory approvals

MET N RTL

CE mark

FCC

Printer Dimensions

Controller

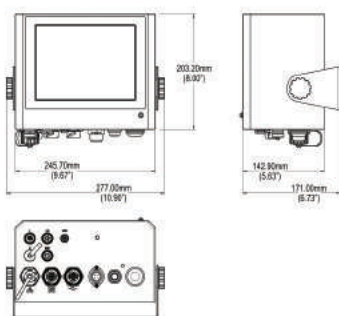

Printhead

